

TFT&U serials T&A Installation

Instruction

Version: 2.1

Date: Nov. 2009

About This Manual

This document describes the TFT&U serials T&A Installation Instruction installation guide and wiring instruction.

Content

1. Before Installing	1
1.1 Notice.....	1
1.2 View of Operation Panel.....	3
1.3 View of Power and Comm. Port	4
1.4 Package List.....	5
1.5 Other required equipment	7
2. Installation	8
2.1 Fix Mounting Plate	8
2.2 Connect with peripheral equipment.....	9
2.2.1 Ethernet connection	10
2.2.2 RS232 Connection	12
2.2.3 RS485 Connection	13
2.2.4 USB Device communications	14
3. Power supply connection.....	16
4. Take test after installation	17
5. Others.....	18
5.1 Reset	18
5.2 Using USB port	19

1. Before Installing

1.1 Notice

Our product is a mass-produced product. It always follows to the criteria of manufacture and inspection of China, U.S.A, and EU closely. This file contains important information. It is better for you to read it carefully prior to use. If you ignore it, the incorrect installation may cause the unit damage. Although we could do our best to offer you service, the neglect to the file could cause unwanted cost for you.

- ◆ Before installation, please make sure the power is cut off, because it is very dangerous if the power is on. The short-circuit of power cable may cause the core parts damage.
- ◆ Connect power supply with device in the last for the wiring connection. If you find any unusual thing occur, please firstly cut off the power, then go to examine. Keep in mind: wiring operation under power on will lead to machine sudden damage; we are not liable for damages and trouble due to such operation.
- ◆ The height to mount device is about 1.4-1.5 meter
- ◆ After installation finish, be sure to tear the dustproof film off on the sensor window, in order to get the best identification effect.
- ◆ Our equipment offer an automatically function, please after the installing finish. Run the auto-test function to confirm the installation finish.

- ◆ In order to guarantee machine run for long time, we set an auto-sleep and wake up function in the exit factory, please carefully examine this function normally setting before using.
- ◆ If your fingerprint machine is powered by AC adapter, use only the original factory –provided AC adapter approved for use with this fingerprint machine. Use of another AC adapter may cause damage; the warranty policy will be invalid.
- ◆ Before device to be connected please read and always follow “Quick connect Guide” closely. Because the wrong wiring will cause the core block and sensor to burn out, insult in device to break down, at this cause our company is not liable for any damages and trouble.
- ◆ If the space between power adapters and device is too long, please do not use the twisted-pair or other type ferrules for the power wire. When the power wire is choused, you should consider attenuation of voltage which has passed long distance transfer.
- ◆ Please use specialized RS485 cable and the RS232/485 converter with power to hookup the network, the bus structure apply to connect with each device. When a long cable is used to transfer signal, it is need to connect a matching resistance to receiver, and its value is 120Ω .

Other not details items; please see also the user handbook, the operating instructions and the appendix and so on

1.2 View of Operation Panel

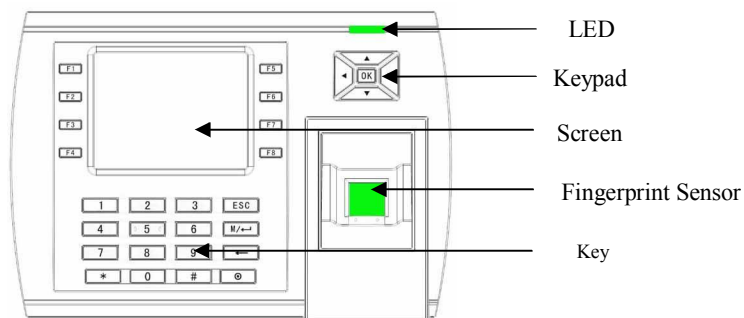

LED light: On normally ready work state the green light glitters once per second; the green light is on for 3 seconds when a user verify successfully. At the same time if the user fails to verify, the red light will be on for 3 seconds.

LCD screen: It displays time, character and operation information.

Fingerprint Sensor: To enroll or verify fingerprint.

Keypad: It is used to input user ID or make menu operation.

1.3 View of Power and Comm. Port

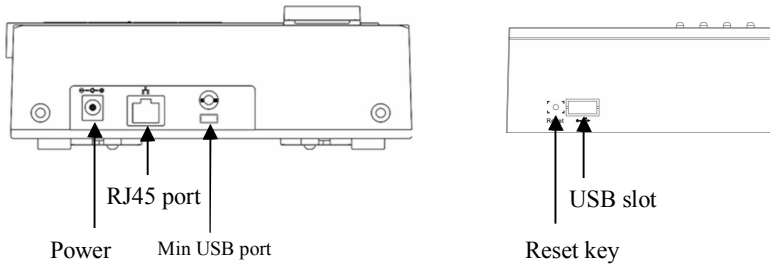

Electrical outlet: Using for connecting the power.

Ethernet port: Using for network connection with the computer through Ethernet





USB slot: Connect USB peripheral device (for example the U flash disk, fingerprint sensor and so on)

Reset key: reset the fingerprint machine, due to operation error or other accident , which leads the machine not to work, you can restart machine through this key

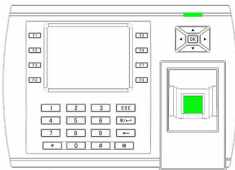

According to different the fingerprint machine model, the layout of fingerprint machine power and communication outlet is different, there are three type of layout.

1.4 Package List

Following list Component, which is not prerequisite, maybe there are not some unit in your fingerprint machine package, please to refer 《Package check list》 .

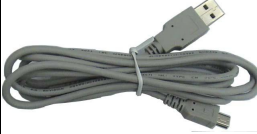

Unit	Picture	Amount	Purpose
Fingerprint machine		1	
Mounting plate		1	Fix fingerprint machine
Power Supply		1	Supply power for fingerprint machine.
RJ45converter cable		1	

Before Installation

USB extension cable		1	
Installing bolt		4	fix the fingerprint machine on the wall
Manual CD			

1.5 Other required equipment

The following equipments are referred in this manual, but do not include the standard package.

Name	Picture	Name	Picture
Computer		RS485 Converter	
Network cable			

2. Installation

2.1 Fix Mounting Plate

- ① Take out a fingerprint machine, dismantle the screw between machine body and mounting plate until it is out, see
- ③ Determine the position of mounting plate on the wall. The fingerprint machine should be mounted on the external wall of the door approximately 1400mm from the ground to the unit bottom. After the position is determined, you could drill a hole for cable out, s.
- ④ Make the hole of mounting plate meet the drilled hole on the wall, Use the screw to fix it on the wall,
- ⑤ After installation, please make sure the mounting plate is reliable, fasten, not loosed.

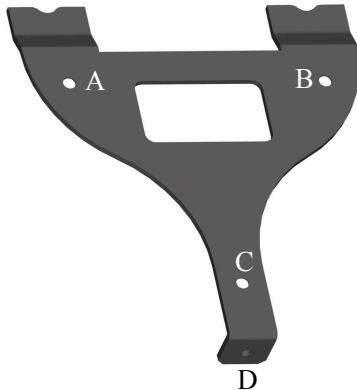

Figure 3-1

2.2 Connect with peripheral equipment

Caution: Do not to connect peripheral equipment before the power of the device is cut down, otherwise it is possible to damage the device badly. Always follow installation instruction closely.

- Ethernet connection
- RS232 connection
- RS485 connection
- USB device connection

2.2.1 Ethernet connection

1) Connects with PC through cross cable

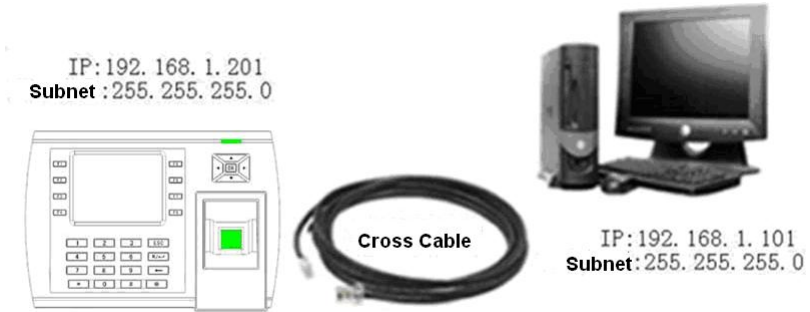

Figure3—2

2) Connects with PC through network and HUB to create a local network.

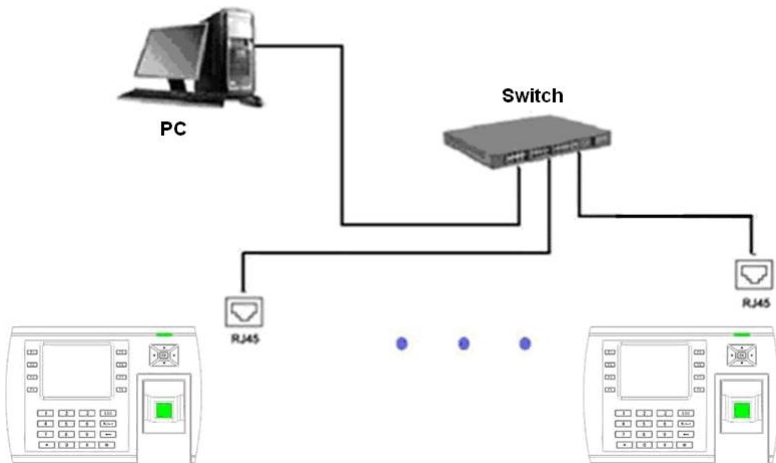
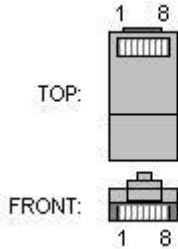

figure3—3

3) RJ45 plug wiring diagrams for Ethernet

a) RJ45 plug standard



b) Ethernet 10/100Base—T Crossover Cable

mostly apply to HUB and Switch, or directly connect two Ethernet terminals(not through HUB), fully support 10Base-T and 100Base-TX.

<i>Plug1</i>	<i>Pin</i>		<i>Pin</i>	<i>Plug 2</i>
TX+	1	<—>	3	RX+
TX-	2	<—>	6	RX-
RX+	3	<—>	1	TX+
RX-	6	<—>	2	TX-

c) Ethernet 10/100Base-T Straight Thru Cable

Support 10Base-T and 100Base-TX, apply to connect with network card and HUB (or network outlet), sometime it is called (whips)”

<i>Wiring standard</i>	<i>Pin</i>	<i>Color</i>	<i>Pin</i>	<i>Wiring standard</i>
TX+	1	<— white orange —>	1	TX+
TX-	2	<— Orange —>	2	TX-
RX+	3	<— white green —>	3	RX+
	4	<— Blue —>	4	
	5	<— Blue white —>	5	
RX-	6	<— Green —>	6	RX-
	7	<— White brown —>	7	
	8	<— Brown —>	8	

2.2.2 RS232 Connection

Along with our fingerprint machine there is a piece of RS232 converter cable supplied, connect one end of the RS232 cable with the RJ45 outlet of fingerprint machine or control box, another one connect to PC serial port.

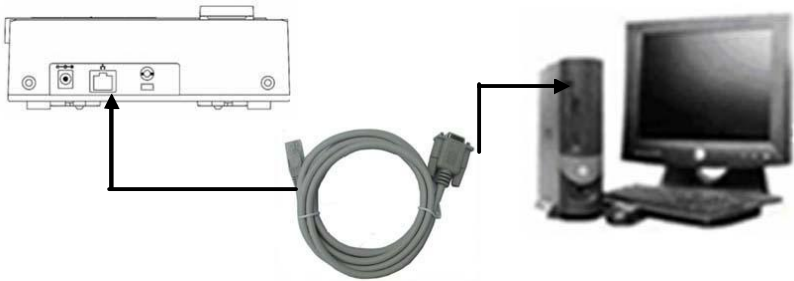

RJ45/RS232converter cable

Notice:

RS 485 converter is not standard supply, If you need to this cable, place contact our technical supporter and market excuter.

2.2.3 RS485 Connection

Along with the fingerprint machine there is a RS485 converter cable supplied , when it is in leaving factory, like as follow picture, one end of RS485 cable is terminal wire, other end is RJ45 jack, plug DB9

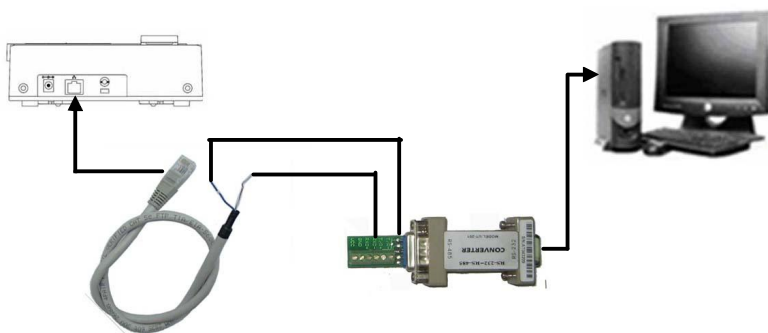

RJ45/RS485 converter cable

Illustration for RJ45/RS485 converter cable:

Blue <—————> 485+
White brown <—————> 485-

Notice:

RS 485 converter is not standard supply, we only provide with RS485 converter cable of the fingerprint machine. If you need to this cable, place contact our technical supporter and market excuter

RS-485 systems using a bus structure configuration connect the more than two fingerprint machine. The transmission line is made by a group of pair-twisted cable. Each transmitted signal has a pair of conductors consisting of inverted and non-inverted signal lines, join RS485 signal ,from RS485 converter, into RS485 network, like as following illustration.

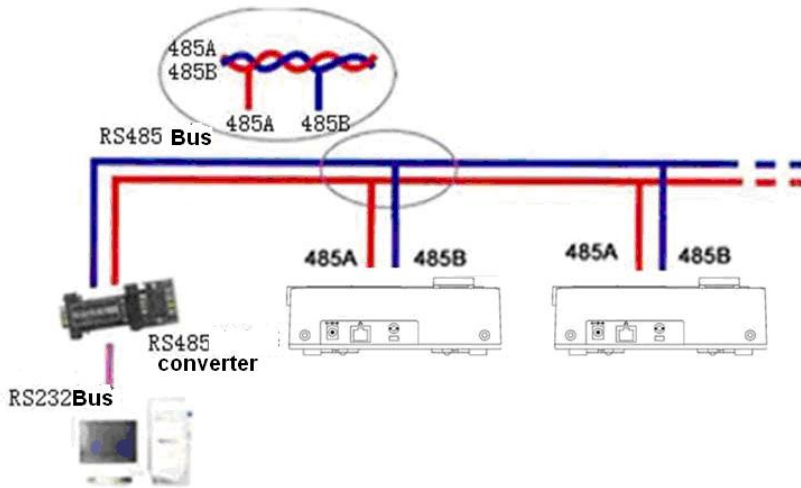
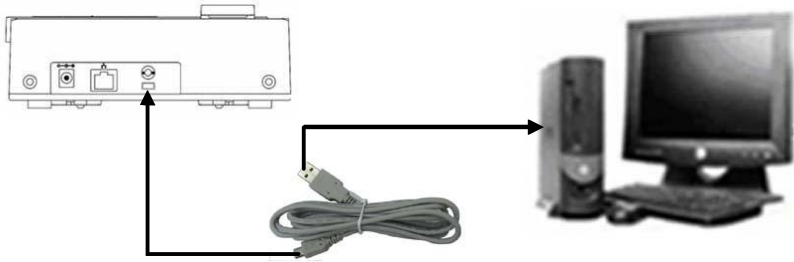

Figure 3—6

2.2.4 USB Device communications

Accompanying with a fingerprint machine there is a USB extension cable, one end of this cable is plugged the mini-USB port of the fingerprint machine , the other end connect with a PC's USB slot.

Machines can be as USB Device that communicate with PC, as shown below.;



USB extension

Note:, after FP Terminal Drive is installed on a PC, this means of communication available. Installing attendance software that comes with the drive will be installed automatically. If you do not use the software the machine with, it is need to download the driver from the company's Web site to manually install.

3. Power supply connection

There are two way to supply fingerprint machine.:

- 1) **power supply** : The fingerprint machine is powered by an AC adapter (220V~5V), the fingerprint machine will automatically start and enter work state

Connection way: plug the adapter plugs into the fingerprint machine power inlets and power on it, see following figure.

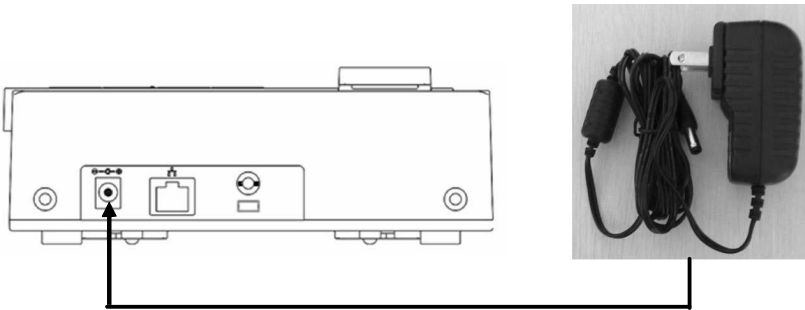

4. Take test after installation

After all system installation finished, make a test and examine prior to power on , inspect whether the lock driver is OK or not,, for more details, please see “User Guide” and “Software Manual”

- ◆ The green LED begins to glitter after power up.
- ◆ Enter menu->Option-> Auto-test.
- ◆ Enter menu->User manage->User Enroll-} Fingerprint Enroll, Enroll a fingerprint, and use the fingerprint to test system.
- ◆ If there is no any problem. Please delete this enrolled fingerprint.

5. Others

5.1 Reset

Due to operation error or other accident, which leads the machine not to work, you can restart machine through reset key.

- ①take a small tool which diameter is no more than 2mm.
- ②find reset mark of “res” on the left small hole on the bottom of device, see following figure.
- ③Use the tool plug into the hole refer to the picture on right , then plug out. The machine is able to restart.

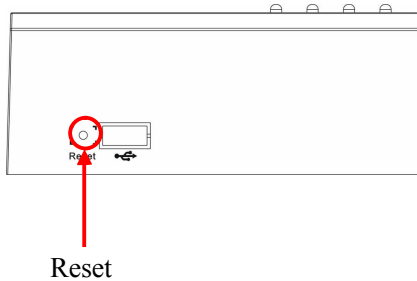

5.2 Using USB port

USB Port can be used to upload and download data by U disk, can be connected with U.are.U fingerprint sensor as an external fingerprint sensor. For more detail, please contact us to get technical assistance.

1. There is a USB slot on the left side of the fingerprint machine, shown as follow.
2. Standard USB slot: directly plug only USB equipment

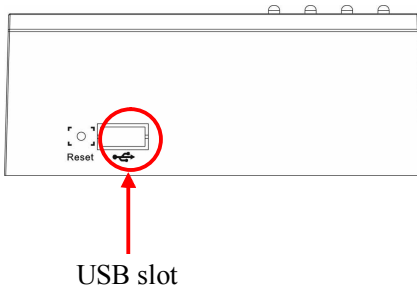



Information in this document is subject to change without notice
Printed in China